

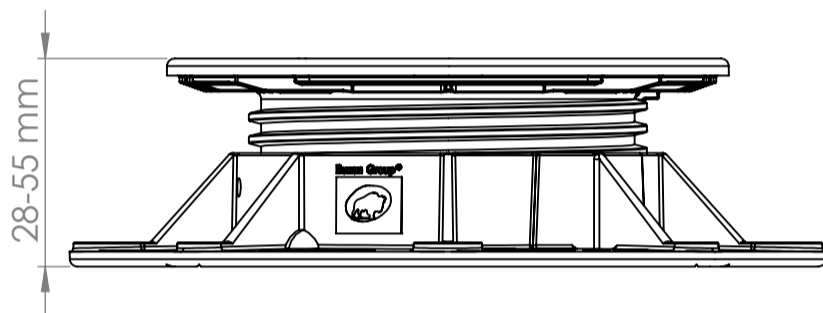

BUZON PEDESTAL INTERNATIONAL
4ème Avenue, 25
B-4040 Herstal - Belgium
T.: +32 (0)4 248 39 83
F.: +32 (0)4 264 82 38
www.buzon-world.com

Scale :1:2

BC-2



FRONT VIEW

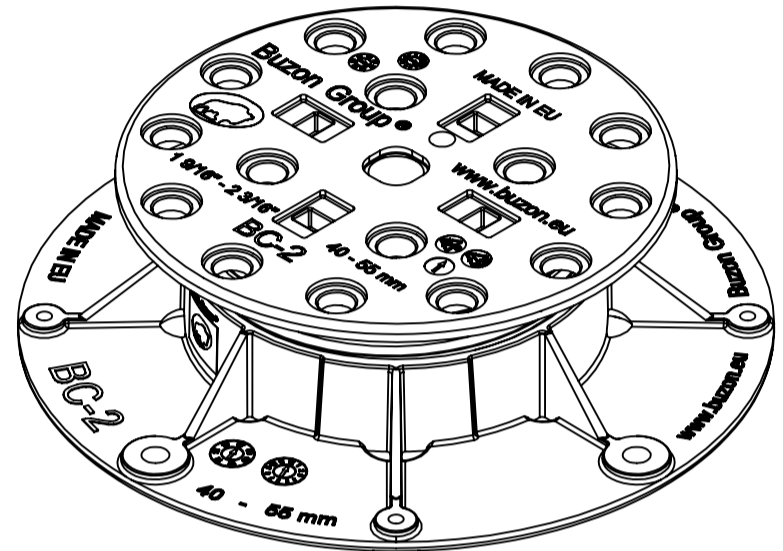

ISOMETRIC VIEW

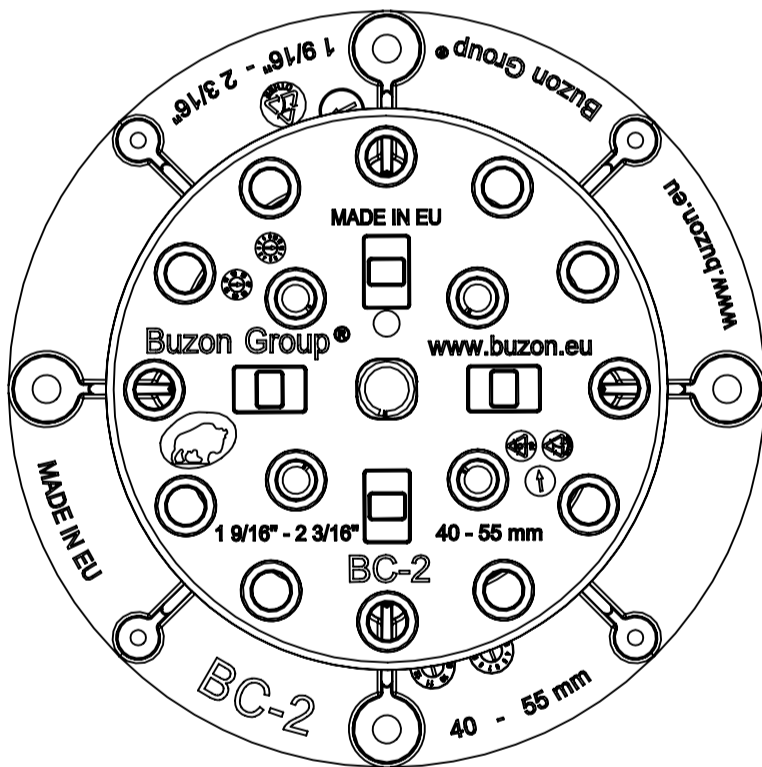

TOP VIEW

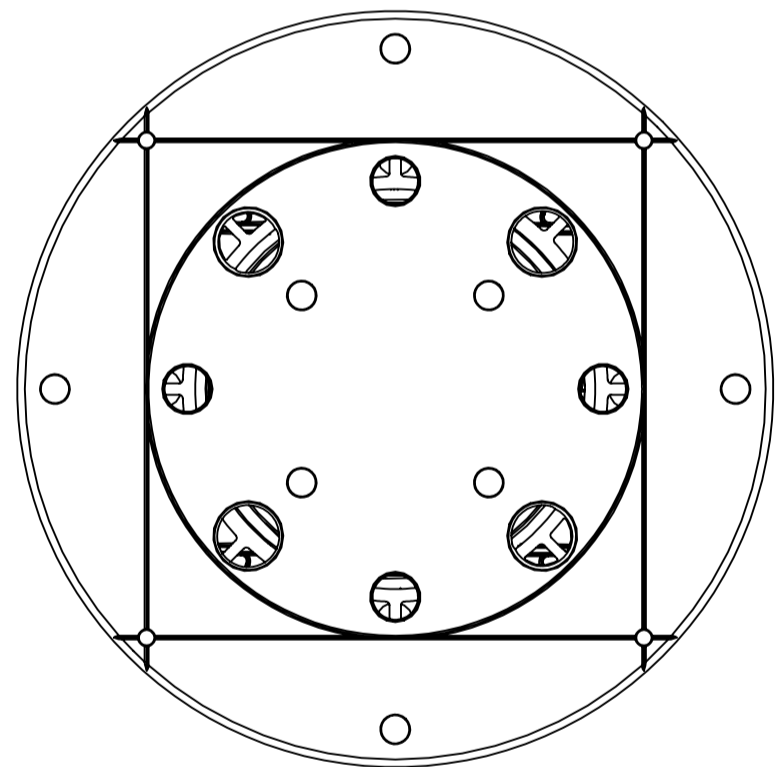

BOTTOM VIEW

NOTES:

1. TECHNICAL INFORMATION REFERRING TO TECHNICAL DATA SHEET.
2. INSTALLATION TO BE COMPLETED IN ACCORDANCE WITH MANUFACTURER'S SPECIFICATIONS.
3. SCALE DRAWING.
4. THIS DRAWING IS INTENDED FOR USE BY ARCHITECTS, ENGINEERS, CONTRACTORS, CONSULTANTS AND DESIGN PROFESSIONALS FOR PLANNING PURPOSES ONLY. THIS DRAWING MAY NOT BE USED FOR CONSTRUCTION.
5. ALL INFORMATION CONTAINED HEREIN WAS CURRENT AT THE TIME OF DEVELOPMENT, BUT MUST BE REVIEWED AND APPROVED BY THE PRODUCT MANUFACTURER TO BE CONSIDERED ACCURATE.